

PR33MF51NSLF Series

$I_T(\text{rms}) \leq 0.3\text{A}$, Non-Zero Cross type
DIP 8pin
Triac output SSD



■Description

PR33MF51NSLF Solid State Device (SSD) is an integration of an infrared emitting diode (IRED), a Phototriac Detector and a main output Triac. This device is ideally suited for controlling high voltage AC loads with solid state reliability while providing 4kV isolation ($V_{\text{iso}}(\text{rms})$) from input to output.

■Features

1. Output current, $I_T(\text{rms}) \leq 0.3\text{A}$
2. Non-zero crossing functionary
3. 8 pin DIP package (SMT gullwing also available)
4. High repetitive peak off-state voltage ($V_{\text{DRM}} : 600\text{V}$)
5. Superior noise immunity ($dV/dt : \text{MIN. } 100\text{V}/\mu\text{s}$)
6. Response time, $t_{\text{on}} : \text{MAX. } 100\mu\text{s}$
7. High isolation voltage between input and output ($V_{\text{iso}}(\text{rms}) : 4\text{kV}$)
8. RoHS directive compliant

■Agency approvals/Compliance

1. Approved by UL508 file No.E94758 (as model No.**R33MF5**)
2. Approved by CSA file No.063705 (as model No.**R33MF5**)
3. Optionary approved by VDE (DIN EN 60747-5-5), file No.40008898 (as model No.**R33MF5**)
4. Package resin : UL flammability grade (94V-0)

■Applications

1. Isolated interface between high voltage AC devices and lower voltage DC control circuitry.
2. Switching motors, fans, heaters, solenoids, and valves.
3. Phase or power control in applications such as lighting and temperature control equipment.

SKY TECH
ELECTRONIC

Notice The content of data sheet is subject to change without prior notice.

In the absence of confirmation by device specification sheets, SHARP takes no responsibility for any defects that may occur in equipment using any SHARP devices shown in catalogs, data books, etc. Contact SHARP in order to obtain the latest device specification sheets before using any SHARP device.

■ Pin-Number and internal connection diagram

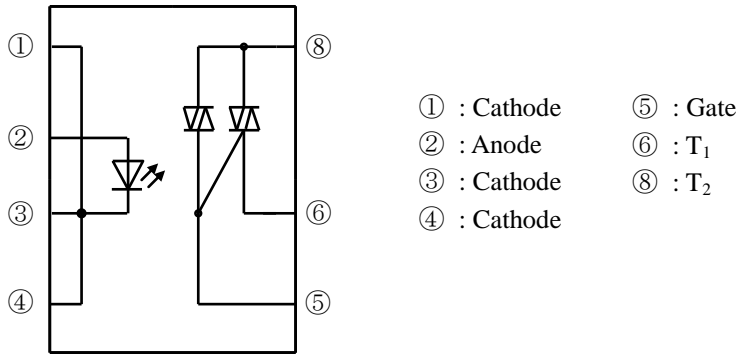

■ Outline Dimensions

(Unit : mm)

<p>1. Through-Hole [ex. PR33MF51NSLF]</p> <p>Product mass : approx. 0.56g</p>	<p>2. SMT Gullwing Lead-Form [ex. PR33MF51NPLF] may not be available</p> <p>Product mass : approx. 0.54g</p>
<p>3. Through-Hole VDE option [ex. PR33MF51YSLF]</p> <p>Product mass : approx. 0.56g</p>	<p>4. SMT Gullwing Lead-Form VDE option [ex. PR33MF51YPLF]</p> <p>Product mass : approx. 0.54g</p>

Plating material : SnCu (Cu : TYP.2%)

Date code (3 digit)

1st digit				2nd digit		3rd digit					
Year of production				Month of production		Day of production					
A.D.	Mark	A.D.	Mark	Month	Mark	Day	Mark	Day	Mark	Day	Mark
2010	A	2022	P	January	1	1	1	13	D	25	S
2011	B	2023	R	February	2	2	2	14	E	26	T
2012	C	2024	S	March	3	3	3	15	F	27	U
2013	D	2025	T	April	4	4	4	16	G	28	V
2014	E	2026	U	May	5	5	5	17	H	29	X
2015	F	2027	V	June	6	6	6	18	J	30	Y
2016	H	2028	W	July	7	7	7	19	K	31	Z
2017	J	2029	X	August	8	8	8	20	L	-	-
2018	K	2030	A	September	9	9	9	21	N	-	-
2019	L	2031	B	October	O	10	A	22	O	-	-
2020	M	2032	C	November	N	11	B	23	P	-	-
2021	N	:	:	December	D	12	C	24	R	-	-

repeats in a 20 year cycle

Factory identification mark

Factory identification Mark	Country of origin
▽	China

* This factory marking is for identification purpose only.
Please contact the local SHARP sales representative to see the actual status of the production.



■ Absolute maximum ratings

Ta=25°C

Parameter		Symbol	Rating	Unit
Input	Forward current	I _F	50 *3	mA
	Reverse voltage	V _R	6	V
Output	RMS on-state current	I _{T(rms)}	0.3 *3	A
	Peak one cycle surge current	I _{surge}	3 *4	A
	Repetitive peak off-state voltage	V _{DRM}	600	V
Isolation voltage *1		Viso(rms)	4.0	kV
Operating temperature		Topr	-30 to +85	°C
Storage temperature		Tstg	-40 to +125	°C
Soldering temperature *2		Tsol	270	°C

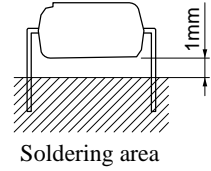

- *1 40 to 60%RH, AC for 1minute, f=60Hz
- *2 for 10s
- *3 Refer to Fig.1, Fig.2
- *4 f=50Hz sine wave

■ Electrical Characteristics

Ta=25°C

Parameter		Symbol	Conditions	MIN.	TYP.	MAX.	Unit
Input	Forward voltage	V _F	I _F =20mA	-	1.2	1.4	V
	Reverse current	I _R	V _R =3V	-	-	10	μA
Output	Repetitive peak off-state current	I _{DRM}	V _D =V _{DRM}	-	-	100	μA
	On-state voltage	V _T	I _T =1.2A	-	-	2.5	V
	Holding current	I _H	V _D =6V	-	-	25	mA
	Critical rate of rise of off-state voltage	dv/dt	V _D =1/√2·V _{DRM}	100	-	-	V/μs
Transfer characteristics	Minimum trigger current	I _{FT}	V _D =6V, R _L =100Ω	-	-	10	mA
	Isolation resistance	R _{ISO}	DC500V 40 to 60%RH	5×10 ¹⁰	10 ¹¹	-	Ω
	Turn on time	t _{ON}	V _D =6V, R _L =100Ω, I _F =20mA	-	-	100	μs

■ Model Line-up

Lead Form	Through-Hole		SMT Gullwing		V _{DRM} [V]	Rating Voltage [V]	Rank mark	I _{FT} [mA] (V _D =6V, R _L =100Ω)
	Shipping Package		Taping					
DIN EN60747-5-5	-	Approved	-	Approved	600	AC250	1	MAX.10
Model No.	PR33MF51NSLF	PR33MF51YSLF	PR33MF51NPLF	PR33MF51YPLF				

Please contact a local SHARP sales representative to inquire about production status.

Fig.1 Forward Current vs. Ambient Temperature

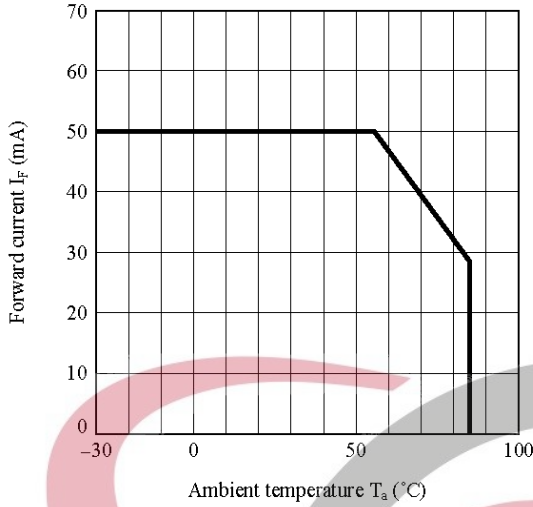

Fig.2 RMS ON-state Current vs. Ambient Temperature

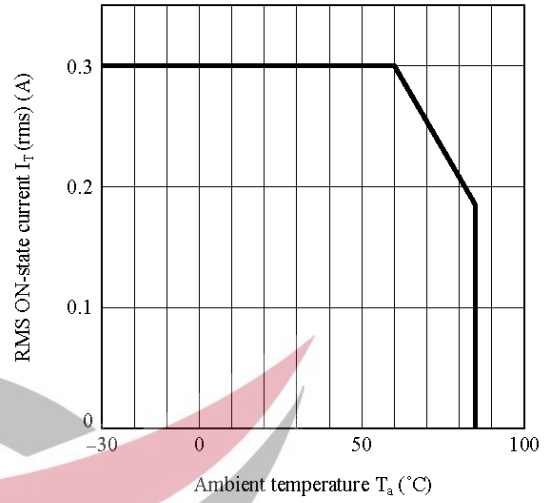

Fig.3 Forward Current vs. Forward Voltage

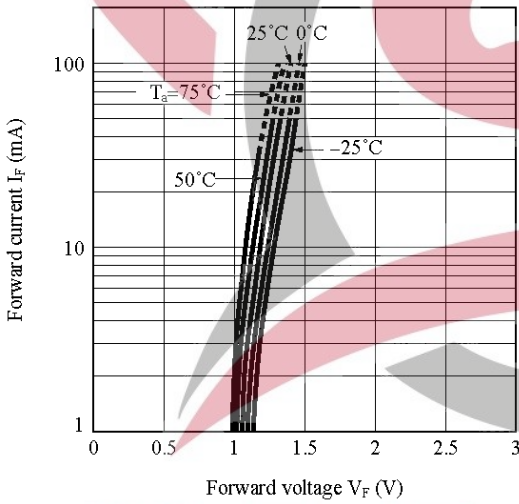

Fig.4 Minimum Trigger Current vs. Ambient Temperature

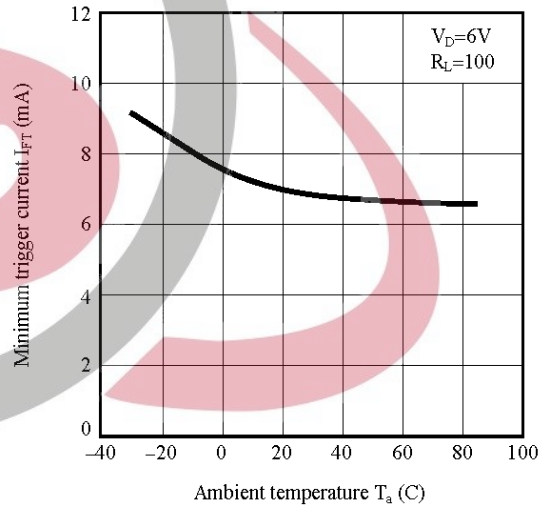

Fig.5 ON-state Voltage vs. Ambient Temperature

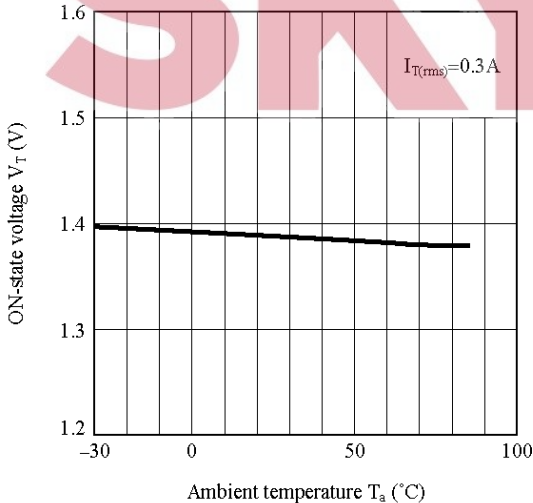

Fig.6 Relative Holding Current vs. Ambient Temperature

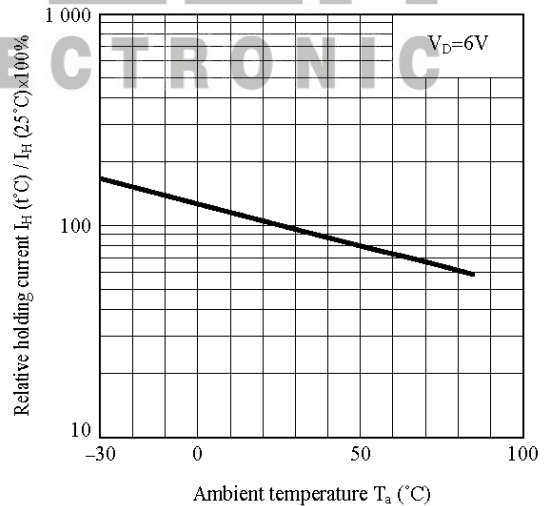

Fig.7 ON-state Current vs. ON-state Voltage

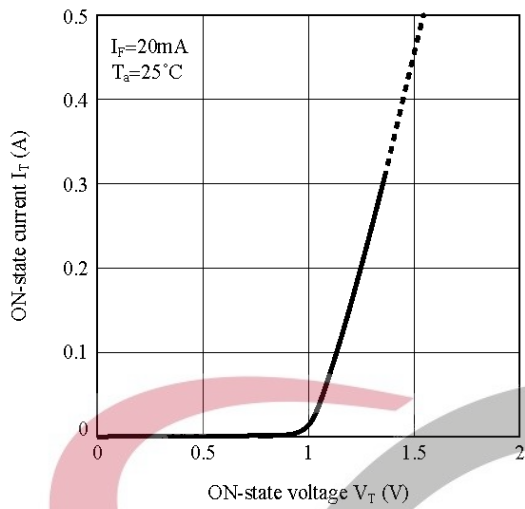
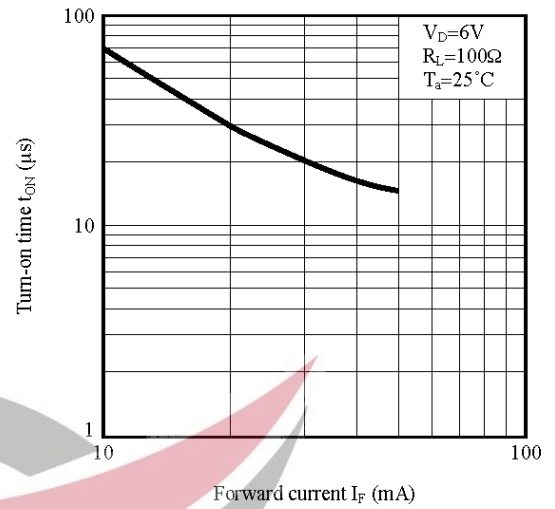

Fig.8 Turn-on Time vs. Forward Current



Remarks : Please be aware that all data in the graph are just for reference and not for guarantee.



■ **Design Considerations**

● **Recommended Operating Conditions**

	Parameter	Symbol	Condition	MIN	MAX	Unit
Input	Input signal current at ON state	$I_F(ON)$	-	20	25	mA
	Input signal current at OFF state	$I_F(OFF)$	-	0	0.1	mA
Output	Load supply voltage	$V_{OUT(rms)}$	-	-	240	V
	Load supply current	$I_{OUT(rms)}$	Locate snubber circuit between output terminals ($C_s=0.022\mu F$, $R_s=47\Omega$)	-	$I_T(rms) \times 80\% (*)$	A
	Frequency	f	-	50	60	Hz
Operating temperature		T_{opr}	-	-20	80	°C

(*) See Fig.2 about derating curve ($I_T(rms)$ vs. ambient temperature).

● **Design guide**

In order for the SSD to turn off, the triggering current (I_F) must be 0.1mA or less

In phase control applications or where the SSD is being by a pulse signal, please ensure that the pulse width is a minimum of 1ms.

When the input current (I_F) is below 0.1mA, the output Triac will be in the open circuit mode. However, if the voltage across the Triac, V_D , increases faster than rated dV/dt , the Triac may turn on. To avoid this situation, please incorporate a snubber circuit. Due to the many different types of load that can be driven, we can merely recommend some circuit values to start with : $C_s=0.022\mu F$ and $R_s=47\Omega$. The operation of the SSD and snubber circuit should be tested and if unintentional switching occurs, please adjust the snubber circuit component values accordingly

When making the transition from On to Off state, a snubber circuit should be used ensure that sudden drops in current are not accompanied by large instantaneous changes in voltage across the Triac. This fast change in voltage is brought about by the phase difference between current and voltage. Primarily, this is experienced in driving loads which are inductive such as motors and solenods. Following the procedure outlined above should provide sufficient results.

Any snubber or Varistor used for the above mentioned scenarios should be located as close to the main output triac as possible.

All pins shall be used by soldering on the board. (Socket and others shall not be used.)

● **Degradation**

In general, the emission of the IRED used in SSD will degrade over time.

In the case where long term operation and / or constant extreme temperature fluctuations will be applied to the devices, please allow for a worst case scenario of 50% degradation over 5years.

Therefore in order to maintain proper operation, a design implementing these SSDs should provide at least twice the minimum required triggering current from initial operation.

● Recommended Foot Print (reference)
SMT Gullwing Lead-form

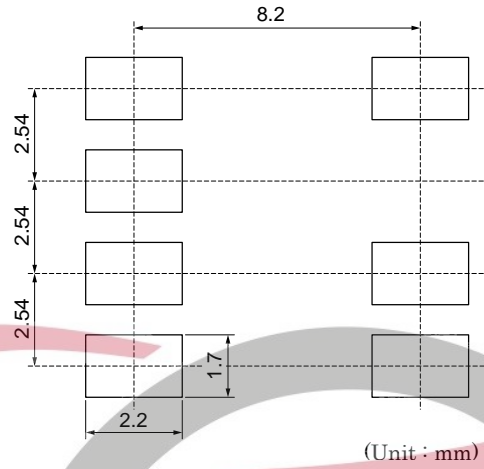

● Standard Circuit

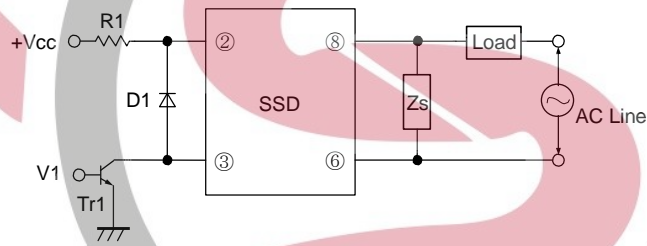

☆ For additional design assistance, please review our corresponding Optoelectronic Application Notes.

■ **Manufacturing Guidelines**

● **Soldering Method**

Reflow Soldering:

Reflow soldering should follow the temperature profile shown below.
 Soldering should not exceed the curve of temperature profile and time.
 Please don't solder more than twice.

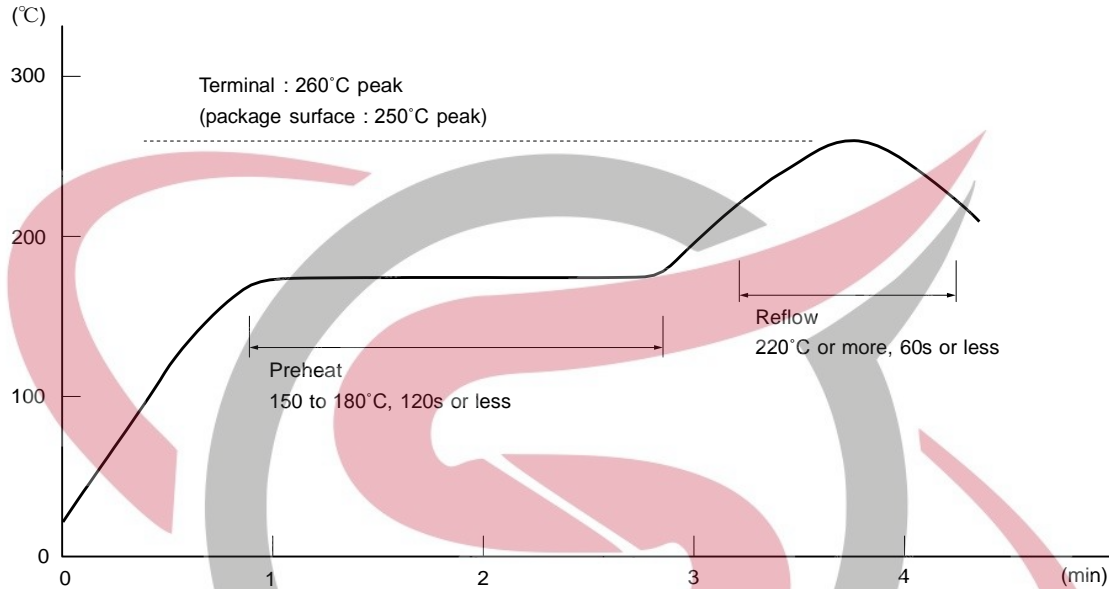

Flow Soldering (No Solder bathing)

Flow soldering should be completed below 270°C and within 10s. Preheating is within the bounds of 100 to 150°C and 30 to 80s. Please don't solder more than twice.

Hand soldering

Hand soldering should be completed within 3s when the point of solder iron is below 400°C. Please don't solder more than twice.

Other notice

Please test the soldering method in actual condition and make sure the soldering works fine, since the im- pact on the junction between the device and PCB varies depending on the tooling and soldering conditions

● **Cleaning instructions**

Solvent cleaning :

Solvent temperature should be 45°C or below. Immersion time should be 3minutes or less.

Ultrasonic cleaning :

The impact on the device varies depending on the size of the cleaning bath, ultrasonic output, cleaning time, size of PCB and mounting method of the device.

Therefore, please make sure the device withstands the ultrasonic cleaning in actual conditions in advance of mass production.

Recommended solvent materials :

Ethyl alcohol, Methyl alcohol and Isopropyl alcohol

In case the other type of solvent materials are intended to be used, please make sure they work fine in actual using conditions since some materials may erode the packaging resin.

● **Presence of ODC**

This product shall not contain the following materials.

And they are not used in the production process for this device.

Regulation substances : CFCs, Halon, Carbon tetrachloride, 1.1.1-Trichloroethane (Methylchloroform)

Specific brominated flame retardants such as the PBB and PBDE are not used in this product at all.

The RoHS directive(2011/65/EU)

This product complies with the RoHS directive(2011/65/EU) .

Object substances: mercury, lead, cadmium, hexavalent chromium, polybrominated biphenyls (PBB) and polybrominated diphenyl ethers (PBDE)

Content of six substances specified in Management Methods for Control of Pollution Caused by Electronic Information Products Regulation

(Chinese : 电子信息产品污染控制管理办法).

Marking Styles for the Names and Contents of the Hazardous Substances

Category	Hazardous Substances					
	Lead (Pb)	Mercury (Hg)	Cadmium (Cd)	Hexavalent chromium (Cr ⁶⁺)	Polybrominate d biphenyls (PBB)	Polybrominate d diphenyl ethers (PBDE)
Solid State Device	×	○	○	○	○	○

This table is prepared in accordance with the provisions of SJ/T 11364.

○ : Indicates that said hazardous substance contained in all of the homogeneous materials for this part is below the limit requirement of GB/T 26572

× : Indicates that said hazardous substance contained in at least one of the homogeneous materials used for this part is above the limit requirement of GB/T 26572

The marking "×" in the above table indicates the exemption of RoHS directive (2011/65/EU), where the elimination or substitution of the restrictive substances is still immature technically and impracticable economically from a current scientific view.

■ Package specification**● Sleeve package****Trough-Hole****Package materials**

Sleeve : HIPS or ABS with preventing static electricity
Stopper : Styene-Elastomer

Package method

MAX. 50pcs of products shall be packaged in a sleeve.

80th ends shall be closed by tabbed and tabless stoppers.

The product shall be arranged in the sleeve with its anode mark on the tabless stopper side.

MAX. 20 sleeves in one case.

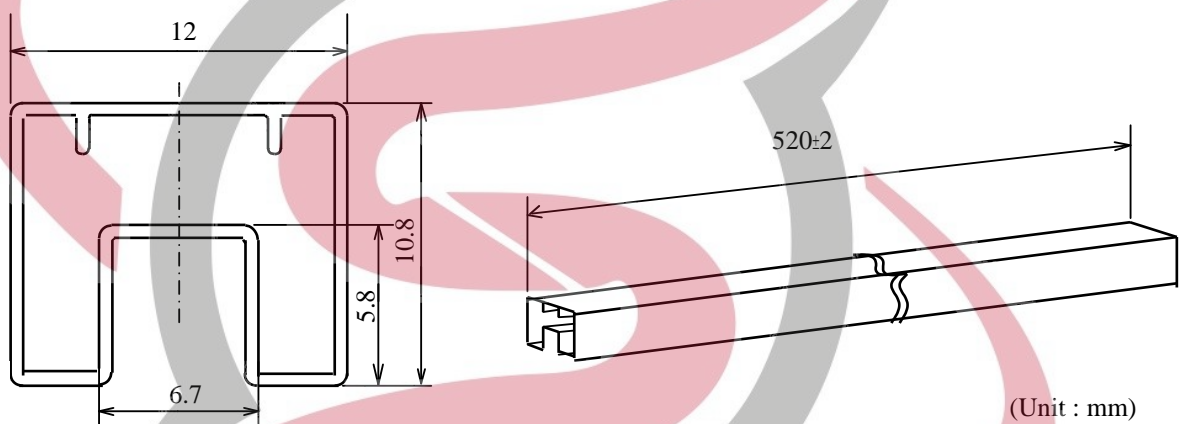
Sleeve outline dimensions

SKY **TECH**
ELECTRONIC

● **Tape and Reel package**

SMT Gullwing

Package materials

Carrier tape : A-PET or PS (with preventing anti-static material)

Cover tape : PET (three layer system)

Reel : PS

Carrier tape structure and Dimensions

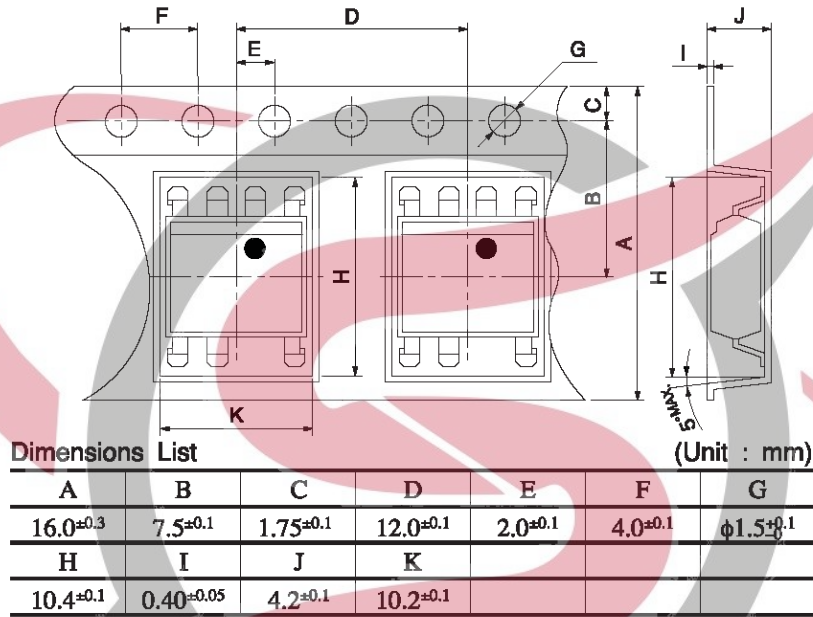

Reel structure and Dimensions

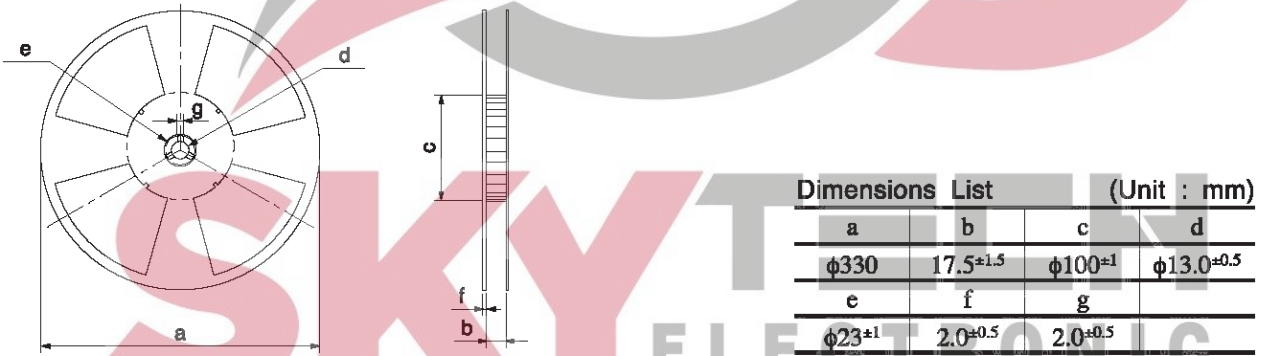

Direction of product insertion

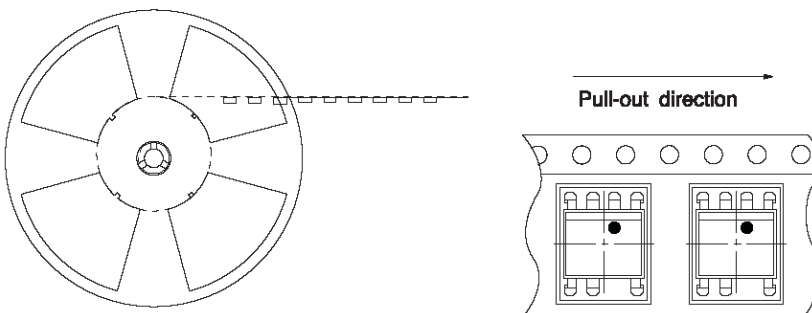

[Packing : 1 000pcs/reel]

■ Important Notices

· The circuit application examples in this publication are provided to explain representative applications of SHARP devices and are not intended to guarantee any circuit design or license any intellectual property rights. SHARP takes no responsibility for any problems related to any intellectual property right of a third party resulting from the use of SHARP's devices.

· Contact SHARP in order to obtain the latest device specification sheets before using any SHARP device. SHARP reserves the right to make changes in the specifications, characteristics, data, materials, structure, and other contents described herein at any time without notice in order to improve design or reliability. Manufacturing locations are also subject to change without notice.

· Observe the following points when using any devices in this publication. SHARP takes no responsibility for damage caused by improper use of the devices which does not meet the conditions and absolute maximum ratings to be used specified in the relevant specification sheet nor meet the following conditions:

(i) The devices in this publication are designed for use in general electronic equipment designs such as:

- Personal computers
- Office automation equipment
- Telecommunication equipment [terminal]
- Test and measurement equipment
- Industrial control
- Audio visual equipment
- Consumer electronics

(ii) Measures such as fail-safe function and redundant design should be taken to ensure reliability and safety when SHARP devices are used for or in connection

with equipment that requires higher reliability such as:

- Transportation control and safety equipment (i.e., aircraft, trains, automobiles, etc.)
- Traffic signals
- Gas leakage sensor breakers
- Alarm equipment
- Various safety devices, etc.

(iii) SHARP devices shall not be used for or in connection with equipment that requires an extremely high level of reliability and safety such as:

- Space applications
- Telecommunication equipment [trunk lines]
- Nuclear power control equipment
- Medical and other life support equipment (e.g., scuba).

· If the SHARP devices listed in this publication fall within the scope of strategic products described in the Foreign Exchange and Foreign Trade Law of Japan, it is necessary to obtain approval to export such SHARP devices.

· This publication is the proprietary product of SHARP and is copyrighted, with all rights reserved. Under the copyright laws, no part of this publication may be reproduced or transmitted in any form or by any means, electronic or mechanical, for any purpose, in whole or in part, without the express written permission of SHARP. Express written permission is also required before any use of this publication may be made by a third party.

· Contact and consult with a SHARP representative if there are any questions about the contents of this publication.

SKY **TECH**
ELECTRONIC